

Line switch with/without bowden cable, fuseh. 5x20/6.3 x 32 mm, voltage sel. (series-parallel)

Standard- or Medical-Filter



C14

 70° C



Description

- Panel Mount:
Screw-on from front side
- 5 Functions:
Inlet, Line switch, Fuseholder with interchangeable fuse drawer for Fuse-links 5 x 20 mm or 6.3 x 32 mm, Voltage selector (series-parallel), Line filter in standard and medical version
- Quick connect terminals 4.8 x 0.8 mm
- Alternative: version without line filter [KG](#)

Approvals

- VDE License Number: 40004665 (FKSA, FKSB)
- UL License Number: E72928 (FKSA, FKSB)

Characteristics

- All single elements are already partially wired
- For added safety "Extra-Safe" fuse drawers are available
Fuse drawer meets requirements of medical standard IEC/EN 60601-1
The fuse drawer can only be opened with the aid of a tool
The fuseholder is accessible from the equipment front
- Qualified for use in equipment according IEC/EN 60950

References

[General Product Information](#)

Weblinks

[Approvals](#), [RoHS](#), [CHINA-RoHS](#), [e-Store](#), [SCHURTER-Stock-Check](#), [Distributor-Stock-Check](#)

Technical Data

Ratings IEC	1 - 10A @ Ta 40 °C / 250VAC; 50Hz
Ratings UL/CSA	1 - 10A @ Ta 40 °C / 125VAC; 60Hz
Leakage Current	standard < 0.5 mA (250V / 60Hz) medical < 5 µA (250 V / 60 Hz)
Dielectric Strength	> 1.7kVDC between L-N > 2.7kVDC between L/N-PE Test voltage (2 sec)
Allowable Operation Temp.	-25 °C to 85 °C
Climatic Category	25/085/21 acc. to IEC 60068-1
Degree of Protection	from front side IP 40 acc. to IEC 60529
Protection Class	Suitable for appliances with protection class I acc. to IEC 61140
Terminal	Quick connect terminals 4.8 x 0.8 mm
Panel Thickness s	Screw-on: max 8 mm Mounting screw torque max 0.5Nm
Material: Housing	Thermoplastic, black, UL 94V-0

Appliance-Inlet/-Outlet	C14 acc. to IEC/EN 60320-1, UL 498, CSA C22.2 no. 42 (for cold conditions) pin-temperature 70 °C, 10A, Protection class I
Fuseholder	1 or 2 pole, Shocksafe category PC2 acc. to IEC 60127-6, for fuse-links 5 x 20 or 6.3 x 32 mm
Rated Power Acceptance @ Ta 23 °C	5 x 20: 2.5W (1 pole)/ 2W (2-pole) per pole 6.3 x 32: 3.15W (1 pole)/ 2.5W (2-pole) per pole
Power Acceptance @ Ta > 23°C	Admissible power acceptance at higher ambient temperature see derating curves
Line Switch	Rocker switch 2-pole, non-illuminated, acc. to IEC 61058-1 Technical details
Voltage selector	series-parallel, 4, 3 or 2 switch positions or usable as 2-pole change-over switch
Line Filter	Standard and Medical Version, IEC 60939, IEC 60601-1, UL 1283, UL 544, EN 133 200, CSA C22.2 no. 8 Technical details
MTBF	> 1'100'000h acc. to MIL-HB-217 F

Dimensions
CG

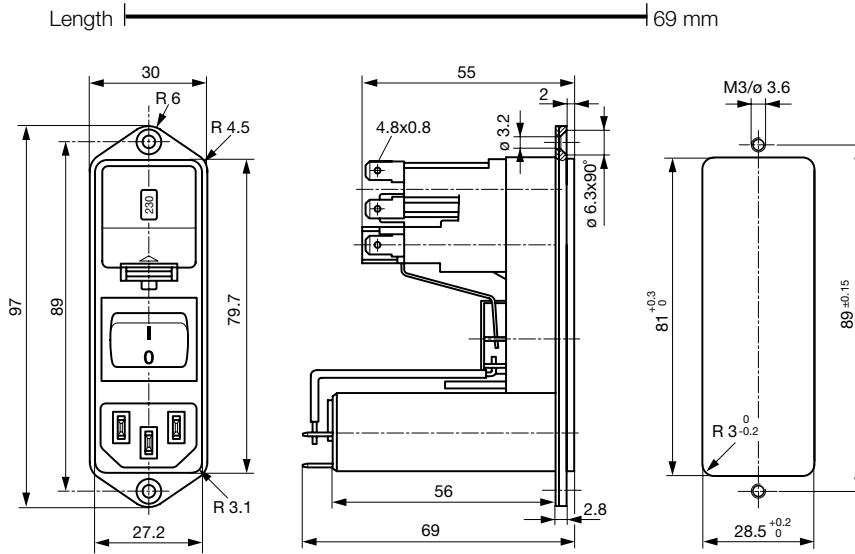

Technical Data of Filter-Components

Rated Current [A]	Filter-Type	Inductances L [mH]	Capacitance CX [nF]	Capacitance CY [nF]	R [MΩ]
1	Standard Version	2 x 10	68	2.2	-
2	Standard Version	2 x 4	68	2.2	-
4	Standard Version	2 x 1.5	68	2.2	-
6	Standard Version	2 x 0.8	68	2.2	-
10	Standard Version	2 x 0.3	68	2.2	-
1	Medical Version (M5)	2 x 10	68	-	1
2	Medical Version (M5)	2 x 4	68	-	1
4	Medical Version (M5)	2 x 1.5	68	-	1
6	Medical Version (M5)	2 x 0.8	68	-	1
10	Medical Version (M5)	2 x 0.3	68	-	1

Diagrams

Standard version
with fuseholder 1- or 2-pole

Medical version
with fuseholder 2-pole

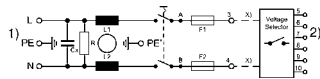
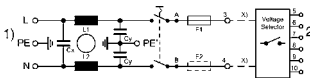

1) Line
2) Load

1) Line
2) Load

Derating Curves for Fuseholders

Fuses 5 x 20 mm

(1-pole)

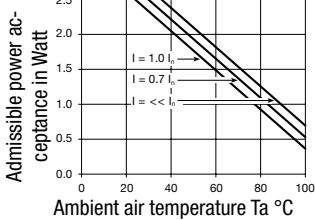

Fuses 5 x 20 mm

(2-pole, per pole)

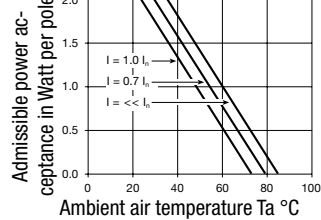

Fuses 6,3 x 32 mm

(1-pole)

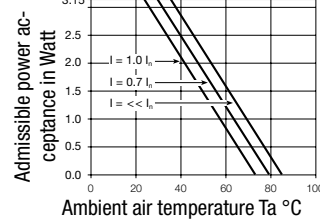

Fuses 6,3 x 32 mm

(2-pole, per pole)

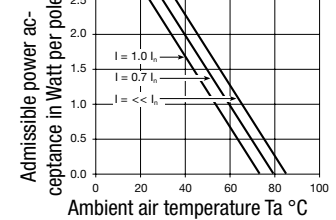

Attenuation Loss

Standard version

--- differential mode — common mode

1 A

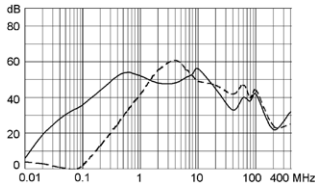

2 A

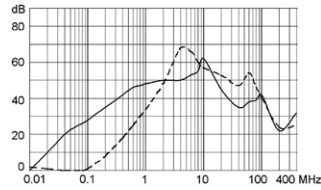

4 A

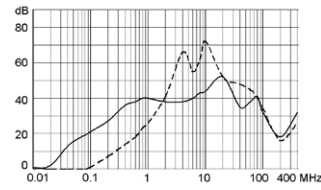

6 A

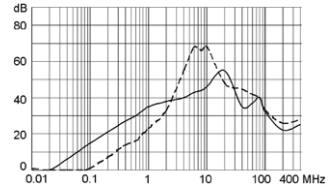

10 A

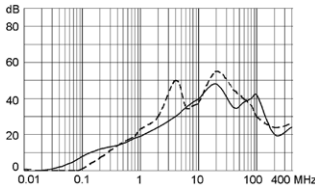

Medical version (M5)

1 A

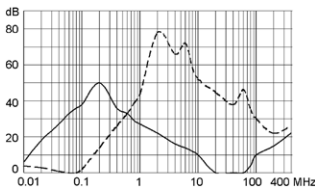

2 A

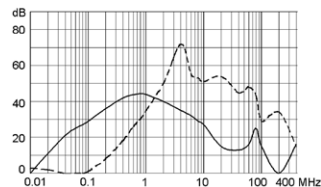

4 A

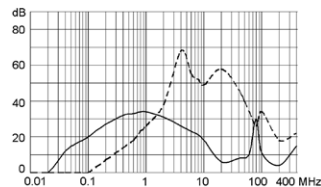

6 A

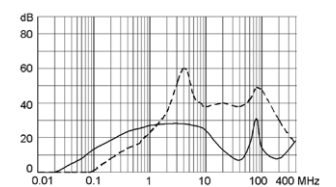

10 A

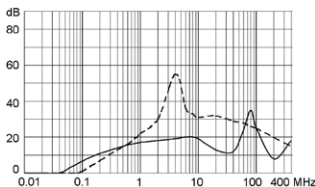

Variants

[Distributor-Stock-Check](#) | [SCHURTER-Stock-Check](#) | [e-Store](#)

Fuse drawer and voltage selector insert must be ordered separately.

Type	Rated Current [A]	Filter-Type	Fuseholder	Line Switch	Line Switch	Order Number
CG	1	Standard Version	2-pole	2-pole	Rocker switch	CG10.6101.151
CG	1	Standard Version	1 pole	2-pole	Rocker switch	CG16.5101.151
CG	2	Standard Version	2-pole	2-pole	Rocker switch	CG20.6101.151
CG	2	Standard Version	1 pole	2-pole	Rocker switch	CG26.5101.151
CG	4	Standard Version	2-pole	2-pole	Rocker switch	CG30.6101.151
CG	4	Standard Version	1 pole	2-pole	Rocker switch	CG36.5101.151
CG	6	Standard Version	2-pole	2-pole	Rocker switch	CG40.6101.151
CG	6	Standard Version	1 pole	2-pole	Rocker switch	CG46.5101.151
CG	10	Standard Version	2-pole	2-pole	Rocker switch	CG60.6101.151
CG	10	Standard Version	1 pole	2-pole	Rocker switch	CG66.5101.151
CG	1	Medical Version (M5)	2-pole	2-pole	Rocker switch	CGG0.6101.151
CG	2	Medical Version (M5)	2-pole	2-pole	Rocker switch	CGA0.6101.151
CG	4	Medical Version (M5)	2-pole	2-pole	Rocker switch	CGC0.6101.151
CG	6	Medical Version (M5)	2-pole	2-pole	Rocker switch	CGE0.6101.151
CG	10	Medical Version (M5)	2-pole	2-pole	Rocker switch	CGL0.6101.151

Packaging unit 10 Pcs

Required Accessory

Description



Jumper Wire 1
Connection with Starnded Cable

Type B, 100	0881.0074
Type B, 100	0881.0075
Type A, 100	0881.0076
Type A, 100	0881.0077



Fusedrawer 1
Drawer for fuse links 5x20mm resp. 6.3x32mm

5 x 20, 2-pole	4305.0001
5 x 20, 1 pole	4305.0006
6.3 x 32, 2-pole	4305.0011
6.3 x 32, 1 pole	4305.0016
...	...



Voltage Selectors Insert 1
Voltage Selector Insert to KE, CE, KG, CG

3 or 4 switch positions	4305.0048.00
1, 3 or 4 switch positions, 100, 120, 220, 240	4305.0048.01
3, 3 or 4 switch positions, 130, 110, 240, 220	4305.0048.02
2, 2 switch positions, 110, 220	4305.0048.03
...	...

Accessory



Assorted Covers
Rear Cover

0859.0109



Cord retaining kits
Cord retaining strain relieve

Flat head, A	4700.0001
--------------	-----------